



Actalyke® MINI II

Activated Clotting Time Test System



Operator's Manual

**Catalog Number 5753, 110-220 VAC, 50-60 Hz
(single well / dual detector with printer)**

**Catalog Number 5755, 110-220 VAC, 50-60 Hz
(single well / dual detector)**

List of Sections

Section 1 - Instrument Use and Function	1-1
Section 2 - Principles of Operation	2-1
Section 3 - Precautions and Limitations	3-1
Section 4 - Hazards	4-1
Section 5 - Installation Instructions	5-1
5.1. Unpacking and Inspection	5-1
5.2. Installation	5-1
5.3. Verification of Functionality.....	5-2
Section 6 - Controls and Displays	6-1
6.1. Controls and Indicators.....	6-1
6.2. Sound Volume and Tone Adjustment.....	6-1
Section 7 - Operating Instructions	7-1
7.1. Summary Instructions for Clotting Time Tests.....	7-1
7.2. Results.....	7-1
7.3. To Abort Operation	7-1
7.4. Printer (optional feature).....	7-2
7.5. Battery (optional feature)	7-2
Section 8 - Test Functions and Quality Control	8-1
8.1. Daily QC	8-1
8.1.1. Clotting Time QC	8-1
8.1.2. Temperature QC (Test Well Temperature Check).....	8-1
8.2. QC of Individual Coagulation Assays	8-1
Section 9 - Performance Specifications	9-1
9.1. Instrument Performance Specifications.....	9-1
Section 10 - Maintenance, Troubleshooting, Warranty	10-1
10.1. Maintenance	10-1
10.1.1. Clotting Time Check.....	10-1
10.1.2. Cleaning the Instrument.....	10-1
10.1.3. Test Well Temperature Check	10-1
10.1.4. Cleaning the Test Well.....	10-1
10.1.5. Replacing Printer Paper	10-2
10.1.6. Battery Replacement Actalyke MINI II Battery Pack, Catalog Number 5754	10-2
10.2. Troubleshooting.....	10-5
10.3. Warranty	10-8
10.4. Regulatory Information	10-8
Section 11 - Symbology	11-1

Section 12 - Bibliography12-1

List of Figures

Figure 1-1. ACTALYKE MINI II with Printer Option1-2

Figure 1-2 Block Diagram.....1-3

Figure 5-1. Battery Cover Removal.....5-3

Figure 5-2. Battery Connection5-3

Figure 6-1. ACTALYKE MINI II with Printer, front view.....6-2

Figure 6-2. ACTALYKE MINI II with Printer, back view.....6-3

Figure 10-1 Preventive Maintenance Schedule Checklist10-4

List of Tables

Table 5-1. Inventory.....5-1

Table 5-2. Additional Materials.....5-1

Table 10-1. Maintenance Schedule10-1

Table 10-2. Troubleshooting10-5

Section 1 - Instrument Use and Function

Actalyke® MINI II Activated Clotting Time Test System (Figure 1-1.) is used to perform the Activated Clotting Time (ACT) test, a whole blood coagulation assay used at the patient site to monitor heparin therapy. The system is portable and designed to perform a range of whole blood coagulation tests at the point-of-care, using Activated Clotting Time (ACT) measurement techniques.

ACTALYKE MINI II is intended for in-vitro diagnostic use only, and is for use in a laboratory or point-of-care environment.

The ACTALYKE MINI II System can be used whenever and wherever ACT testing is desired, such as during:

- Hemostasis Laboratory
- Cardiopulmonary Bypass Surgery
- Hemodialysis
- Extracorporeal Membrane Oxygenation (ECMO)
- Percutaneous Transluminal Coronary Angioplasty
- Cardiac Catheterization
- Critical Care

The ACTALYKE MINI II System provides an alternative to other Activated Clotting Time (ACT) methodologies. The instrument monitors moderate to high levels of heparin during various surgical and medical procedures, with good sensitivity, linearity and precision.

The ACTALYKE MINI II System is available in two models, as a dual-detector analyzer with or without a printer. The instrument is modular in construction for enhanced durability, portability, and flexible storage options.

ACTALYKE MINI II contains preprogrammed test parameters. You may not alter the test parameters. With printer option, results are printed.

Actalyke Test Tubes are manufactured to the highest specification for accurate and precise test results. Each tube contains a clotting activator and magnet.

Refer to the procedure supplied with the tubes for information on the following areas:

- Summary
- Principle
- Reagents
- Instruments
- Specimen Collection and Handling
- Reagent Preparation
- Sample Application
- Test Procedure
- Performance Characteristics
- Stability of End Product
- Expected Results
- References
- Interpretation of Results
- Bibliography

The functional units of the ACTALYKE MINI II are shown in Figure 6-1.



Figure 1-1. ACTALYKE MINI II with Printer Option

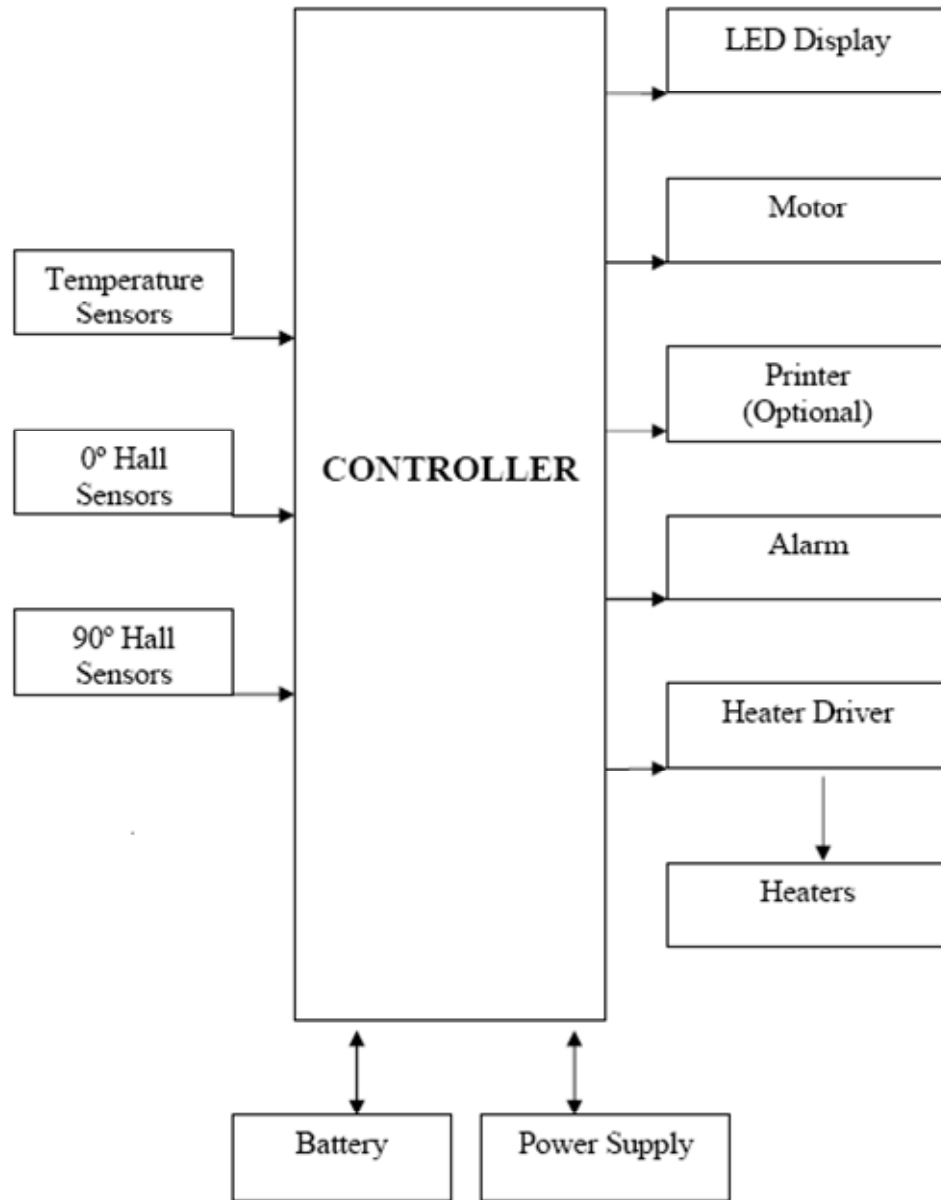

Figure 1-2 Block Diagram

Section 2 - Principles of Operation

Operation is controlled by a microprocessor, its program and memory, and by one push-button controlling selections.

The computer runs a self-test at power on to detect error conditions or potential problems.

If an error is detected, the computer responds by beeping three times. In the event of a hardware error, the instrument will display E###. Refer to section 10.2, Troubleshooting for a list of possible error codes. Note that older versions show an alternating "E ##" and "####" (section 10.2, Troubleshooting). During startup, all segments of the LED display will be turned on. Press the start button to confirm that all segments are on. If any segments are not turned on, the LED display must be serviced.

The test well of the instrument incorporates a highly sensitive clot detection mechanism. The clot detection mechanism operates using a magnet contained in a test tube, and a set of two solid-state, magnetic detectors located in the test well.

One magnetic detector is located at 0° and another at 90°, with respect to the test tube. When a test tube is inserted into the test well, the detector at 0° senses the presence of the magnet as the tube slowly rotates.

As a clot forms, the fibrin strands cause the magnet in the tube to rotate. The detector at 90° senses the motion of the tube magnet and a clotting endpoint is determined. This two-point detection sensing system minimizes the possibility of a missed end-point.

The test well holds the test tube. When **Start** is pressed, the microcomputer turns on the motor, which rotates the test tube. The heater remains at a constant $37^{\circ}\text{C} \pm 0.5$, and is monitored by the internal electronics. When the clotting end-point is detected, the instrument notifies the operator that the procedure is complete by activating an audible indicator and by displaying the

results on the light emitting diode (LED) display.

Section 3 - Precautions and Limitations

3.1. The entire Operator's Manual should be read and understood before attempting instrument operation.

3.2. Refer to the procedures supplied with the activator kits for proper testing protocols.

3.3. Provide adequate room at the sides and back of the instrument for good air circulation.

3.4. Do not expose the instrument to drafts or to direct sunlight. Do not operate at temperatures above 30°C (86°F), or below 15°C (59°F). Do not operate above 80% humidity (non-condensing)

3.5. Do not place the instrument near a strong source of electromagnetic interference, such as a centrifuge, X-ray machine, etc.

3.6. WARNING: Do not use the instrument in any area, which has, or is thought to have, been exposed to explosive gases.

3.7. For AC outlet specification, see the serial number plate located on the instrument.

3.8. For emergency shut down, unplug the instrument power cord. To unplug the instrument from the power supply always disconnect from the AC outlet. Firmly grasp the plug and pull. Do not remove the plug by pulling the line cord. With the power cord disconnected, turn the power switch Off.

3.9. No operation or maintenance should be undertaken by the operator, which requires the removal of the instrument's covers unless specified in this manual.

3.10. Do not use excessive force when making selections on the instrument display.

3.11. Do not attempt to insert any material into the instrument other than an ACT tube, an Electronic Clotting Tube, the temperature probe holder supplied with the Actalyke

Thermometer, or an item this manual indicates as appropriate.

3.12. If resistance is encountered when inserting a tube into the test well, or there is resistance when the tube is rotating, do not force the test tube into the test well. Carefully remove the test tube and check the well. Remove any obstruction before using the instrument further.

3.13. All guidelines pertaining to the handling of fresh whole human blood should be adhered to when handling the test tubes and operating the instrument.

3.14. Used test tubes should be considered contaminated and may represent a biohazard. These should be handled and disposed of in accordance with the user's policy regarding contaminated and biohazardous materials.

3.15. Should instruments be contaminated by blood or blood derivatives, spray commercial virucidal and germicidal agent onto the area contaminated. Observe where specimens are used inside the instrument, and confine cleaning to that area. Wipe up the agent residue, as these materials may contain alcohol, which is corrosive to metal surfaces.

No harsh cleansers, acids, or bases should be used or spilled on inner or outer surfaces. Do not immerse the unit. **ALWAYS TURN THE POWER SWITCH OFF AND UNPLUG THE MAIN POWER CORD BEFORE CLEANING.**

3.16. The instrument's systems are designed for use only with ACT tubes. Do not use the instrument with test tubes that are past the expiration date marked on the tube label and corresponding test tube box.

3.17. With a properly maintained and operated instrument, the prime external factor affecting the accuracy and precision of the test is the quality of the blood specimen used. Specimen contamination, inappropriate operating technique and excessive

temperature variations will also affect the test results.

3.18. The ACT test results may be affected by hemodilution, hypothermia, pharmacologic compounds and various coagulopathies. Test results should be interpreted with respect to the patient's condition and the clinical circumstances, such as anticoagulation therapy.

3.19. Test results, which do not agree with expected values or are inconsistent, should be repeated. Any test result of ≥ 1500 seconds has no clinical value, and the test should be repeated immediately. These samples should be further evaluated using other diagnostic methods, if indicated. See section 7.2.

If further validation of the system is required, several tests should be run using Actalyke Quality Control Materials or other commercial coagulation controls.

3.20. If a printout is to be part of a permanent record, photocopy the printout and save the photocopy.

3.21. Instructions for the "responsible body*" (*Under IEC 61010-2-101:2002 -- the person(s) responsible for the use and maintenance of equipment and for ensuring that operators are adequately trained for eliminating and reducing hazards involved in removal from use, transportation, or disposal.)

3.22. Action(s) to be taken in case of malfunction: See section 3.8 and 10.2.

3.23. Requirements for handling biohazards: Due to potential biohazard risk from human blood, guidelines pertaining to Universal Precautions shall be adhered to when handling the samples and operating this instrument. This includes the use of protective gloves and any other protective equipment as warranted for safe handling and disposal of test tubes and use, transportation and disposal of this device. For

information on minimizing biohazard risk, see section 3.15.

3.24. Storage and transport environmental requirements:

Storage and shipping temperatures: -20° - 45° C

Keep dry. Do not expose to direct precipitation.

Tested to altitudes of 4267 meters.

3.25. The Helena Agent shall provide a power cord or adapter of the proper configuration for the country in which the instrument is to be installed. The power cord or adapter will comply with IEC 60227, IEC 60245, or be certified as rated for the power specified in section 9 of this manual.

Section 4 - Hazards

4.1. If the instrument is used in a manner not specified by this manual, protection provided by equipment design may be impaired.

4.2. This unit contains high voltages, which can be extremely dangerous. **ALWAYS TURN OFF THE POWER, DISCONNECT THE MAIN POWER CORD, AND USE EXTREME CARE** when attempting to clean or repair.

4.3. When operating the instrument on AC power, do not attempt to do so without plugging the power cord into an easily accessible, grounded AC wall outlet of the proper voltage and frequency. This information is contained on the serial number plate located on the instrument.

4.4. Do **not** lubricate the instrument.

4.5. Use only the test tubes specified by the Helena Laboratories procedure in use. Damage to the instrument may result from introducing some types of solutions into the instrument.

4.6. Follow safe handling and disposal procedures for test tubes used with this device.

4.7. Keep flammable liquids and flammable vapors away from the instrument at all times.

4.8. Particular symbols may be used to provide information to the user. Refer to Section 11 - Symbology.

4.9. Use only specified printer paper.

4.10. Follow these guidelines for proper battery disposal:

1. Totally discharge the battery.
2. Do not incinerate.
3. Do not open or crush cells.
4. Observe all Federal, State and Local regulations for disposal of rechargeable cells.

4.11. **WARNING:** Do not use non-rechargeable batteries.

Section 5 - Installation Instructions

WARNING: Read section three, Precautions and Limitations, and section four, Hazards, before attempting installation or device operation.

5.1. Unpacking and Inspection

1. Check all shipping containers for signs of damage. If damage is found, immediately notify the shipping carrier.
2. Carefully unpack instrument and accessories from the shipping cartons. The packing material should be removed undamaged, if possible, should repacking be necessary.
3. Remove plastic wrappings from the instrument and accessories. If scissors or a knife are used to cut the plastic or binding tape, take care not to scratch the instrument.
4. Inspect the instrument for any obvious signs of damage. If damage is found, notify shipping carrier and Helena Laboratories.
5. Inventory all items. If any parts are missing, recheck the packing materials before notifying Helena Laboratories.

Table 5-1. Inventory

5755 Actalyke MINI II single well / dual detector
Actalyke MINI II Instrument
Power Cord
Installation Report
Operator's Manual
5753 Actalyke MINI II single well / dual detector with printer
Actalyke MINI II Instrument
Power Cord
Installation Report
Operator's Manual
Roll of Actalyke Thermal Printer Paper

Table 5-2. Additional Materials

	Required Materials
XL-ECT	Actalyke Electronic Clotting Tube
A-PPR	Actalyke Thermal Printer Paper (only for models 5753 and 5763)

Available Materials

5754	Actalyke MINI II Battery Pack
5757	Actalyke Thermometer
C-ACT	Celite Tube
K-ACT	Kaolin Tubes
G-ACT	Glass Bead Tubes
MAX-ACT	MAX-ACT tubes
AQC-HP	Actalyke Whole Blood QC (for C-ACT, K-ACT, & MAX-ACT)
AQC-LP	Actalyke Whole Blood QC (for G-ACT)
5754	Actalyke MINI II Battery Pack

5.2. Installation

This instrument is a Category II device under EN 61010-1, for use in a laboratory or similar environment.

1. Select an environment free of drafts, direct sunlight, dust, and temperature fluctuations. Ambient temperature should be between 15°C to 30°C (59°F to 86°F).
2. Place the instrument on a flat, rigid, horizontal surface, preferably located near the patient. Using the carrying handle/stand, prop up the instrument.
3. If the optional Actalyke MINI II Battery Pack, Catalog Number 5754, is to be used, install the battery as follows:
 - a. Confirm that the instrument power is Off and that it is unplugged from the wall outlet.
 - b. Remove the battery cover. Use care when removing the battery cover not to disconnect the wires connecting the battery cover and the instrument (Figure 5-1).
 - c. Remove the battery cover. Use care when removing the battery cover not to disconnect the wires connecting the battery cover and the instrument (Figure 5-2).
 - d. Install the battery (Catalog Number 5754) by plugging the battery connector into the P3 location on the printed circuit board located in the battery cover. Press down onto connector until the locking tabs engage.

e. Place the battery pack under the rubber pegs and press until the battery pack rests against the foam pad on the back surface of the cover.

f. Replace the battery cover and secure with the screws and washers removed in step 3b. Use care to ensure that there are no wires damaged during the installation of the battery pack and cover.

4. The one connector, accessible from the rear, is an IEC connector. Plug the power cord into this connector and plug the other end into a grounded wall outlet of the proper voltage and frequency. Because the power cord is the mains disconnect device, the wall outlet used should be easily accessible. These specifications can be found on the serial number plate located on the instrument.

The wall outlet should not be on the same circuit as any large load device such as a refrigerator, compressor, centrifuge, etc. The instrument circuitry contains filters to reduce the effect of line voltage fluctuations; however, they should still be avoided.

5. If the unit has a printer, load the roll of printer paper; see section 10.1.5 for instructions.

6. If a backup battery was installed, the battery may need charging for up to 18 hours to be at full capacity. Full capacity should allow for two hours of usage on battery power. The backup battery needs charging for a minimum of two hours to allow for a minimum of 30 minutes of usage on battery power. To charge the backup battery, plug in and turn On the instrument.

5.3. Verification of Functionality

Read the entire Operator's Manual. Complete the applicable section of the **Actalyke MINI II Installation Report** as the following steps are performed:

1. Using the power switch located at the rear of the instrument, turn the unit on. Four

dashes will appear across the instrument display.

2. Verify the **Operating Environment Temperature** falls within the specified range. Refer to section 9.1 for specifications. Make the necessary notations on the installation report.

3. Perform **Test Well Temperature Check**. Refer to section 10.1.3 for instructions. Make the necessary notations on the installation report.

4. Perform **Clotting Time Check**. Refer to section 10.1.1 for instructions. Make the necessary notations on the installation report.

5. Perform a **QC of Individual Coagulation Assay**. Refer to the procedure supplied with the Actalyke tubes for instructions. Make the necessary notations on the installation report.

Should any problems occur during installation, refer to section 10.2 or call Helena Laboratories.

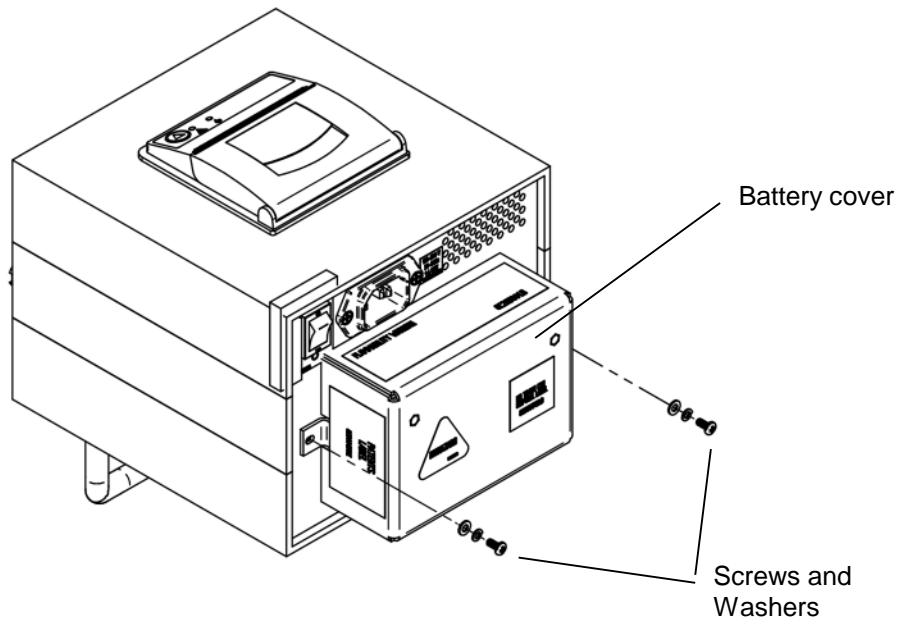

Figure 5-1. Battery Cover Removal

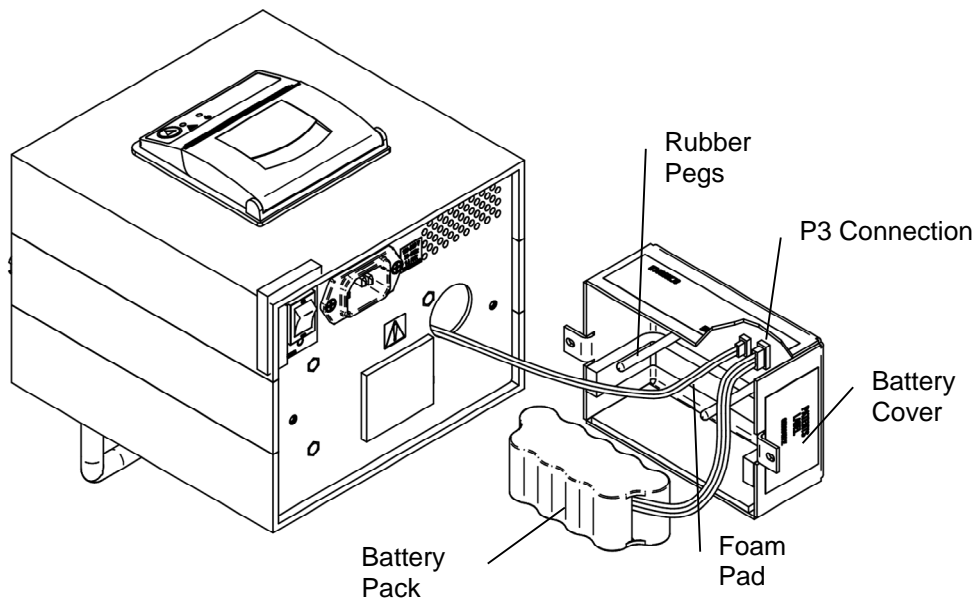

Figure 5-2. Battery Connection

Section 6 - Controls and Displays

6.1. Controls and Indicators

The following descriptions refer to Figure 6-1. and Figure 6-2..

1. START button: Starts or stops a clotting test.

2. Detector indicator: Illuminates when the detector has sensed the presence of the rotating magnet within the tube and flashes when the current clotting test is complete.

3. Heater indicator: Illuminates when the test tube heater is active.

4. LED display: A 4-character light emitting diode (LED) display is provided. The display shows test results and error messages.

5. Test Well: Insert test tube here to perform clotting test.

6. Paper Advance button: If the instrument has a printer, it will also have a paper advance button. Use the paper advance button to load new paper rolls and to advance the paper to read or remove a printout.

7. Power Switch: The power switch must be On to use the instrument and/or, if the instrument has a backup battery, to charge the battery.

8. IEC Connector: Plug the power cord into this connector on the rear of the instrument.

9. Battery Cover: Included on all instruments. Protects rear of instrument and/or battery.

10. Battery Cover Screws and Washers: The screws and washers secure the battery cover and are used to access the battery connection when installing/replacing the battery.

6.2. Sound Volume and Tone Adjustment

The instrument's sound and tone can be adjusted. The instrument has twelve different volume/tone combinations.

With the instrument in normal run mode and with no tube in the test well, press and hold the **Start** button. After three seconds of pressing and holding the button, the instrument will begin emitting the different sound combinations and displaying an *L* and a number for each combination.

The instrument will continuously progress through the twelve combinations, in one-second intervals, until you release the **Start** button.

The sound emitted immediately prior to releasing the **Start** button is now the selected volume/tone combination.

With a combination selected, the instrument returns to the normal run mode and is ready for operation.

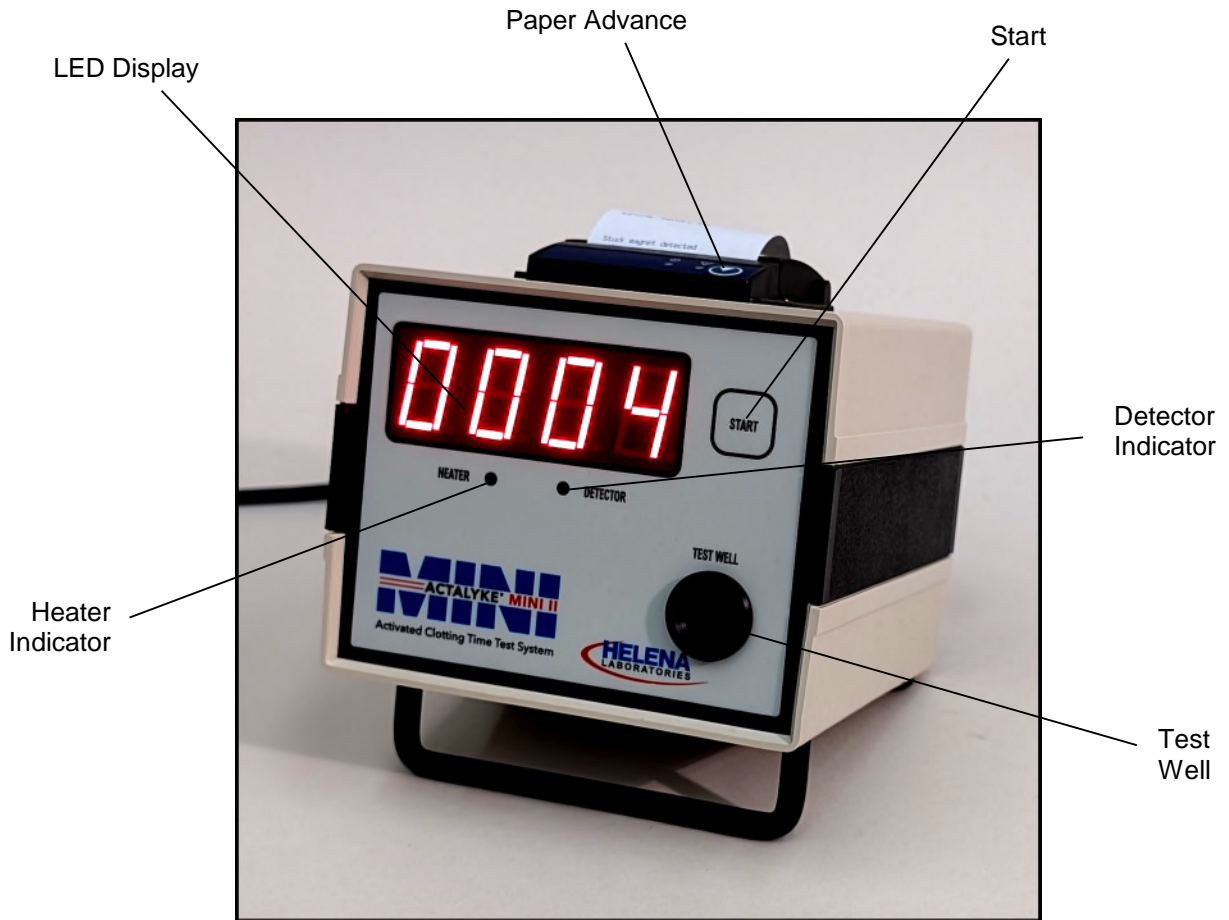

Figure 6-1. ACTALYKE MINI II with Printer, front view
Front Panel Controls and Displays Indicated



**Figure 6-2. ACTALYKE MINI II with Printer, back view
Back Panel Controls and Battery Access Indicated**

Section 7 - Operating Instructions

7.1. Summary Instructions for Clotting Time Tests

Please refer to activator package insert (Actalyke test tube: C-ACT, K-ACT, G-ACT and MAX-ACT) for a detailed description of performing an ACT clotting test.

The instructions for specimen collection and handling, activator preparation, and preparation of patient samples and controls, are in the appropriate sections of the activator procedure supplied with the tubes.

1. Collect the patient sample according to the procedure for the tube in use.
2. Open the flip top of the tube.
3. Dispense the required amount into the tube and, if desired, manually start the instrument's timer by pressing the **Start** button. Note that the tube must be inserted into the test well within 85 seconds of **Start** being pressed, or the test will abort.
4. Close the tube flip top and mix the tube's contents according to the procedure.
5. Insert the tube into the test well and, if the timer was not manually started in step 3, the timer automatically starts.
6. Rotate the tube according to the procedure. The green detector indicator should be on. If it is not, rotate the tube clockwise until it is.
7. For the remainder of the test, the tube is automatically rotated until clotting is detected in the sample. If the tube is removed from the test well or **Start** is pressed during the test, the test will abort.
8. The red heater indicator will turn on and off periodically throughout the testing time.
9. During a test, if the instrument detects an error, its response depends on the type of error and when the error is detected. If the instrument detects a stuck magnet during the first 45 seconds of a test, the beeper sounds every five seconds until either the problem is

resolved or until 45 seconds have elapsed. If a stuck magnet is detected after 45 seconds, the instrument aborts the test and the error message "E003" is displayed. If the instrument has a printer, "<E003> Stuck magnet detected after 45 seconds" will be printed.

Note: *On older versions of the instrument, "-S-1" is displayed instead.*

If the instrument detects a missing test tube after 45 seconds have elapsed, the beeper sounds every 5 seconds until the tube is inserted or the timer reaches 85 seconds, at which point the test is aborted and, if the instrument has a printer, prints "<E015> Test aborted, no tube inserted after 85 seconds". For more information, see section 10.2.

10. Upon clot detection, the beeper sounds, the clotting test result is displayed in seconds, and the detector indicator flashes five times. Additionally, if the instrument has a printer, the results print out.

11. When the test tube is removed from the instrument, the unit is then ready to start a new test. The clotting time will remain on the display until another tube is inserted or **Start** is pressed.

7.2. Results

Refer to the procedure supplied with the ACT tubes for a complete discussion of Results and Interpretation of Results, Stability of End Product, Expected Values, and Performance Characteristics.

If results on a patient show ≥ 1500 seconds, verify proper unit function by performing the clotting time quality control verification in section 8.1.1.

If further validation of the system is required, several tests should be run using Actalyke Quality Control Materials or other commercial coagulation controls.

7.3. To Abort Operation

To abort operation, press **Start**. A test cannot be aborted for the first 5 seconds.

7.4. Printer (optional feature)

1. The printer automatically prints information and cannot be customized.
2. For instructions on loading printer paper see section 10.1.5.
3. To read or remove printout, press the paper advance button until the paper has advanced enough for it to be read or removed.
4. The printer assembly includes a serrated plate. This plate is used to tear off printouts or excess paper. Older printer assembly also include two black thumbscrews located one on each side of the plate. These screws are used to control the position of the plate. The plate's position may need to be adjusted when loading paper or dealing with a paper jam.

7.5. Battery (optional feature)

The instrument can contain a rechargeable battery (Catalog Number 5754) as a backup power source. The battery will act as an uninterruptible power supply in the event of a power outage. The battery available for use in this instrument is a nickel metal hydride. This type of battery does not require full discharge prior to re-charging. Therefore, when the instrument is plugged into an AC outlet and the power switch is On, the battery is being continuously recharged for one hundred percent capacity at all times. If the battery becomes fully discharged, it should be recharged for a **minimum of two hours to obtain 30 minutes** of usage on battery power. To fully recharge the backup battery, and provide for **two hours of usage on battery power, charge the battery for 18 hours**. If the unit displays 'E002 it will not allow you to start a new test. Connect the instrument to wall power or turn the instrument off until it can be connected to wall power. Leaving the instrument powered on with a low battery will eventually over-discharge the battery.

Section 8 - Test Functions and Quality Control

Routine quality control testing and tracking should be part of a comprehensive quality assurance program. Quality Control products are available for routine Actalyke tests.

8.1. Daily QC

The instrument automatically performs a self-test any time the power is turned On. Should an error message appear on the display, see section 10.2.

8.1.1. Clotting Time QC

The ACT Electronic Clotting Tube (ECT), Catalog Number A-ECT, and the Actalyke Electronic Clotting Tube (ECT), Catalog Number XL-ECT, are available for verification of clotting time. Follow the instructions provided in the package insert for operation of the ECT in use.

8.1.2. Temperature QC (Test Well Temperature Check)

1. If using an Actalyke Thermometer, Catalog Number 5757, to perform a temperature check of the test well, refer to the installation instructions included with the Actalyke Thermometer. Then proceed to step 5.
2. To use a different temperature-sensing device, the device must have a minimum accuracy at 37°C of $\pm 0.2^\circ\text{C}$. Also needed are an empty glass test tube (100 mm long x 13 mm diameter) and 1 mL of water.
3. Fill the test tube with the water and place the test tube into the test well. Allow the test tube to equilibrate for a minimum of five minutes.
4. Then, place the temperature-sensing device into the water filled test tube. Allow the device to stabilize for three minutes and note the temperature registered.
5. The temperature should remain in a range of 36.5 to 37.5 °C. If the temperature exceeds this range, see section 10.2.

8.2. QC of Individual Coagulation Assays

Each box of Actalyke Activated Clotting Time tubes contains 50 agonist tubes from a single manufactured lot. Before use, perform a verification test one time with the appropriate Actalyke Whole Blood QC Kit (AQC-H, or AQC-L). Perform this test on one box of each lot, each time a shipment of tubes is received. Acceptable ranges for the various Actalyke coagulation assays are included in the appropriate Quality Control procedure.

Section 9 - Performance Specifications**9.1. Instrument Performance Specifications**

Measurement Range: 90 - 1500 seconds

Incubation Temperature: 36.5°C - 37.5°C

Dimensions: width x height x depth
6.5" x 5" x 8.5"

Weight (with printer and battery): 6.5 pounds

Line Voltage: 50 - 60 Hz, 110 - 220 V A/C

Power (watts): ~ 110

Fuses, located internally. Do not attempt to replace fuses.

Instrument Operating Environment:

Ambient Temperature Range -
15°C to 30°C (59 to 86 °F)

Operating Relative Humidity -
10% to 80%, non-condensing

Altitude tested up to 2000 meters

The features of the Actalyke System include:

Testing at point-of-care or laboratory.

Uses fresh whole blood.

Test results within minutes.

Fully portable system.

Test well automatically incubated to 37°C
(± 0.5°C).

Equipment protected throughout by double
insulation or reinforced insulation.

Microprocessor controlled for enhanced
reliability and reporting of fault conditions.

LED (4) 0.8" x 1.0" for easy readability.

Printer option available for hard copy re-
cording of test results.

Battery option available for full operation of
the instrument for 30 minutes with a two-
hour charge.

Test Tube:

Dimensions:

Length - 100 mm

External Diameter - 13 mm

Material: Borosilicate glass or plastic

Style: Round Bottom or Flat Bottom

Label: (for operator identification and tracking)

Test Type: Activator type

Lot No.: Reagent lot number

Exp.: Expiration date of tubes

Section 10 - Maintenance, Troubleshooting, Warranty

10.1. Maintenance

This section describes routine operator maintenance procedures. For instrument calibration or for maintenance not described in this manual, call Helena Laboratories for assistance.

WARNING: ACTALYKE MINI II is factory lubricated. Do NOT lubricate instrument.

Table 10-1. Maintenance Schedule

<u>Daily, if used</u>
Clotting Time Check (2 Levels)
Cleaning the Instrument
<u>Weekly</u>
Test Well Temperature Check
<u>Monthly</u>
Cleaning the Test Well
<u>As Needed</u>
Replacing Printer Paper
Replacing the Battery

Should any technical difficulties arise, it is recommended that multiple tests be run with Whole Blood Quality Control kits and an Electronic Clotting Tube. Results can then be discussed with Helena Laboratories Technical Services Department.

In cases where quality control results fall outside the acceptable range, patient results should be considered suspect. The cause will likely be test technique, control material, instrument, or the coagulation test tube, see section 10.2.

10.1.1. Clotting Time Check

The ACT Electronic Clotting Tube (ECT), Catalog Number A-ECT, and the Actalyke Electronic Clotting Tube (ECT), Catalog Number XL-ECT, are available for verification of clotting time. Follow the instructions provided in the package insert for operation of the ECT in use.

10.1.2. Cleaning the Instrument

TURN OFF THE POWER AND UNPLUG POWER CORD BEFORE PROCEEDING.

Allow the instrument to cool, if necessary. To clean the exterior of the unit, mild soapy water and a lint free wipe should be used. If the outer surface becomes contaminated, use a 10% Sodium Hypochlorite (bleach) solution and a lint free wipe to wipe the exposed surfaces down. Wipe up any excess solution with a lint free wipe. After cleaning with decontaminating agent, use a cotton swab with de-ionized (D.I.) water to remove any residue.

Dry the unit before plugging in the power cord or turning On the power switch.

10.1.3. Test Well Temperature Check

1. If using an Actalyke Thermometer, Catalog Number 5757, to perform a temperature check of the test well, refer to the installation instructions included with the Actalyke Thermometer. Then proceed to step 5.

2. To use a different temperature-sensing device, the device must have a minimum accuracy at 37°C of $\pm 0.2^\circ\text{C}$. Also needed are an empty glass test tube (100 mm long x 13 mm diameter) and 1 mL of water.

3. Fill the test tube with the water and place the test tube into the test well. Allow the test tube to equilibrate for a minimum of 5 minutes.

4. Then, place the temperature-sensing device into the water filled test tube. Allow the device to stabilize for three minutes and note the temperature registered.

5. The temperature should remain in a range of 36.5 to 37.5 °C. If the temperature exceeds this range, see section 10.2.

10.1.4. Cleaning the Test Well

TURN OFF THE POWER AND UNPLUG POWER CORD BEFORE PROCEEDING.

Allow the instrument to cool, if necessary. Clean up any volume of fluid in the well prior to tilting the instrument. If there is an obstruction in the test well, carefully tilt the instrument forward and allow the obstruction to fall out. Take care when handling the obstruction in the event it has sharp edges and/or is a biohazard. Dispose of the obstruction as necessary.

If there is liquid in the test well, assume that the test well is contaminated. As a decontaminating agent, use a 10% Sodium Hypochlorite (bleach) solution on the tip of a cotton swab to clean out the test well. **CAUTION: Do not pour solution into the well.** Wipe up any excess solution with a lint free wipe. After cleaning with decontaminating agent, use a cotton swab with de-ionized (D.I.) water to remove any residue.

10.1.5. Replacing Printer Paper

1. Lift the lever at the top of the printer to open the cover.
2. Install a new paper roll with the leading edge running from the bottom of the roll up at the front side of the instrument. Close the cover and tear the extra paper.
3. Note that older versions of the instrument used a different printer system. For instructions for replacing paper on the older printer, refer to the previous revision of the user manual.

10.1.6. Battery Replacement Actalyke MINI II Battery Pack Catalog Number 5754

1. Confirm the battery is fully discharged by unplugging the power cord from the wall outlet and turning On the instrument. If the battery is not fully discharged (the instrument powers up) then fully discharge the battery by leaving the instrument in this state until the instrument powers off, possibly up to three hours. Once the battery is fully discharged, turn the instrument power Off and unplug the power cord from the

instrument. With a Phillips screwdriver, remove the two screws and washers securing the battery cover located on the rear of the instrument (

2. Figure 5-1.).

3. Remove the battery cover and battery. Use care when removing the battery cover not to disconnect the wires connecting the battery cover and the instrument (Figure 5-2.)

4. Remove the battery from the battery cover and unplug the battery from the printed circuit board located in the battery cover. The connection location is labeled P3 on the circuit board.

5. Install the new battery (Catalog Number 5754) by plugging the battery connector into the P3 location on the printed circuit board located in the battery cover. Press down onto connector until the locking tabs engage.

6. Place the battery pack under the rubber pegs and press until the battery pack rests against the foam pad on the back surface of the cover.

7. Replace the battery cover and secure with the screws and washers removed in step 2. Use care to ensure that there are no wires damaged during the installation of the battery pack and cover.

8. The one connector, accessible from the rear, is an IEC connector. Plug the power cord into this connector and plug the other end into a grounded wall outlet of the proper voltage and frequency. Because the power cord is the mains disconnect device, the wall outlet used should be easily accessible. These specifications can be found on the serial number plate located on the instrument.

Turn on the instrument. Charge the new battery for a minimum of two hours for a minimum of 30 minutes of usage on battery power. To fully recharge the backup

battery, and provide for two hours of usage on battery power, charge the battery for 18 hours.

9. See section 4.10 for information on discarding the spent battery.

Serial Number:

Month/Year:

ACTALYKE® Mini II Preventive Maintenance Schedule																																
	1	2	3	4	5	6	7	8	9	10	11	12	13	14	15	16	17	18	19	20	21	22	23	24	25	26	27	28	29	30	31	
Daily, if Used																																
Clean the Instrument																																
Check Clotting Times (ECT)																																
Weekly																																
Check Well Temperatures																																
Monthly Items																																
Clean the Test Wells																																
Quarterly																																
Drain Battery																																
As Needed																																
Replace Printer Paper																																
Replace fuse(s)																																
Replace Battery																																

Note: Duplicate this page for maintenance copies. Initial each item as required. Refer to section ten, Maintenance, of the Operator's Manual for details. If you are uncertain about how to perform any step, please contact Helena Laboratories Electronic Customer Service Dept. (1-800-231-5663) for more information.

Figure 10-1 Preventive Maintenance Schedule Checklist

10.2. Troubleshooting

If unit appears to be malfunctioning for any reason, thoroughly check for physical damage to the case, indicators, etc. caused by dropping or excessive mishandling. Should instrument problems be suspected, it is recommended that several tests be run using Actalyke Quality Control material and whichever test tubes are used clinically. Results from these tests will be helpful in identifying any potential trend in test results that could indicate a fault within the system. For further information, refer to the Actalyke Quality Control Package Insert.

A hardware error is indicated by an alternating display. If the instrument displays an alternating pattern of “E ##” and “####” where ‘#’ represents some numbers, write down the numbers and report the problem to Helena Laboratories.

The following table lists other symptoms and possible fault conditions and causes.

Table 10-2. Troubleshooting

Symptom	Possible Causes(s)	Action Required
Excessive sample clotting time	Test well temperature out of range	Verify Temperature QC (section 8.1.2), if OK, rerun patient test, if out of range, call Helena Laboratories.
	Test well control problem	Verify Clotting Time QC (section 8.1.1), if OK, rerun patient test, if out of range, call Helena Laboratories.
	High heparin concentration in sample	Verify QC (section 8.1), if OK, rerun patient test, if out of range, call Helena Laboratories.
	Battery charge depleted	Plug cord into wall outlet and turn On to use and charge battery.
Short sample clotting time	Tube not detected and instrument aborted test	Rerun patient test.
	Test well temperature out of range	Verify Temperature QC (section 8.1.2), if OK, rerun patient test, if out of range, call Helena Laboratories.
Segments missing from LED display	Defective display module	Call Helena Laboratories.

Symptom	Possible Causes(s)	Action Required
Detector indicator does not illuminate	Tube not fully inserted into the test well	Reinsert tube.
	Magnet in tube stuck	Turn tube 3 times, to dislodge magnet.
	Magnet inverted in tube	Discard tube.
	Faulty tube	Remove tube and insert ECT, if detector illuminates, discard tube.
	Detector malfunction	Insert ECT, if detector does not illuminate, call Helena Laboratories.
Tube will not rotate	Obstruction in test well	Clean test well.
	Defective drive mechanism	Call Helena Laboratories.
START key non-responsive	Instrument malfunction	Call Helena Laboratories.
Printer not working	Paper jammed	Adjust serrated plate position and inspect mechanism.
	Printer mechanism/driver fault	Call Helena Laboratories.
Clotting time ECT not in range	Insufficient charge in ECT battery	Replace battery; see the ECT instructions.
	Magnetic detector malfunction	Call Helena Laboratories.
Temperature quality control not in range	Insufficient charge in thermometer battery	Replace battery.
	Test well control problem	Call Helena Laboratories.
Individual coagulation assays QC not in range	Faulty tube	Repeat test. If remains out of range, call Helena Laboratories.

Poor Precision	Inaccurate tube agitation	Refer to procedure supplied with the tubes for instructions.
	Inaccurate sample volume	Refer to procedure supplied with the tubes for correct volume.
	Inconsistent time interval between inserting sample into tube and inserting tube into the instrument	Refer to procedure supplied with the tubes for instructions.
Alarm sounds every 5 seconds during the first 45 seconds of test	Magnet in tube stuck	Turn tube 3 times to dislodge magnet.
Error code -STUC or -S-1 on LED display, test aborted, (if printer model, "Stuck magnet detected Test aborted" prints)	Magnet in tube stuck	Discard tube.
	Battery charge depleted	Plug cord into wall outlet and turn On to use and charge battery.
LED displays error	Instrument needs to be reset	Turn power off and on.
	Defective display module	Call Helena Laboratories.
	Battery charge depleted	Plug cord into wall outlet and turn On to use and charge battery.
No power to instrument when on battery power	Battery charge depleted	Plug cord into wall outlet and turn On to use and charge battery.
	Spent backup battery	Replace battery, see section 10.1.6.

Error messages

Message	Description
CL-0	No clot detected after 1500 sec
E001	P8 jumper not installed when machine tilted at startup
E002	Low battery
E003	Magnet stuck
E004	No tube detected 45 seconds after test started
E005	LED driver U2 error
E006	LED driver U3 error
E007	Remote ADC error
E008	RTC error
E009	EEPROM error
E010	I2C bus error
E011	Hall sensor out of range
E012	Motor current fault
E013	Heater current fault
E014	Calibration invalid, recalibrate

10.3. Warranty

Helena Laboratories warrants its products to meet Helena's published specifications and to be free from defects in materials and workmanship. Helena's liability under this contract or otherwise shall be limited to replacement or refund of any amount not to exceed the purchase price attributable to the goods as to which such claim is made. These alternatives shall be the buyer's exclusive remedies. In no case will Helena Laboratories be liable for consequential damages even if Helena has been advised as to the possibility of such damages.

The foregoing warranties are in lieu of all warranties expressed or implied, including, but not limited to, the implied warranties of merchantability and fitness for a particular purpose. In no event will Helena Laboratories be liable for indirect, incidental or consequential damages; the original user's remedies being limited to repair or replacement at the manufacturer's option.

Warranty Duration

This warranty is provided to the original purchaser for **one year from date of sale**.

Particular Exclusions

Unauthorized modification of any part of the Actalyke MINI II instrument will void this Warranty.

10.4. Regulatory Information

EN 60601-1-2 and EN 61010-2-101



















CLIA Regulations: Please refer to Section EIGHT for "Quality Control."





Trademarks and Copyright

Actalyke®, Actalyke® MINI, Actalyke® MINI II and Actalyke® XL are registered trademarks of Helena Laboratories, Inc. This manual is protected under copyright laws of the United States.

Section 11 - Symbology

NOTE: The following symbols may be used in this manual, or on the instrument, to provide information necessary to the user, if applicable.

	Caution, electric shock hazard, high voltages capable of causing personal injury - shut down the instrument and unplug the power cord before touching - do not operate with the cover(s) removed
	Caution, heat hazard - allow heated components to cool before handling
	Caution, general hazard - see Precautions and Hazards (Sections 3 and 4) of Operator's Manual before proceeding
	Direct current
	Alternating current
	Both direct and alternating current
	Ground (earth) terminal
	Protective conductor terminal (grounded conductors)
	Frame or chassis terminal
	Equipotentiality (conductor with all parts at a single potential)
	On (power switch)
	Off (power switch)
	Equipment protected throughout by double insulation or reinforced insulation (equivalent to Class II of IEC 536)
	Authorized representative in the European Community
	Manufacturer
	Caution, Biohazard
	Indicates "do not place in trash" in countries or regions requiring recycling and other specific handling, such as in Europe, under the WEEE (Waste Electrical and Electronic Equipment) Directive, 2002/96/EC
	Indicates "do not place in trash" in countries or regions requiring recycling and other specific handling, such as in Europe, under the WEEE (Waste Electrical and Electronic Equipment) Directive, 2002/96/EC

 SN	Serial number
 i	Consult instructions for use
 REF	Catalog number
	Temperature Limitation
 IVD	<i>In vitro</i> diagnostic medical device

Section 12 - Bibliography

Bibliography National Committee for Clinical Laboratory Standards: Proposed standard procedures for the handling and processing of blood specimens. Vol 1:16, pp. 481-532; 1981.

Ogilby JD, Kopelman HA, Klein LW, Agarwal JB: Adequate heparinization during PTCA: Assessment using activated clotting time. *Catherization and Cardiovasc Diagnosis* 84:II -592; 1989.

Hattersley P: Activated coagulation time of whole blood. *JAMA*, 136:436; 1966.

Doty DB, Knott HW, Hoyt JL, Koepke JA: Heparin dose for accurate anticoagulation in cardiac surgery. *J Cardiovasc Surg* 1979; 20: 597-604.

Hattersley PG: Heparin Anticoagulation. In: Koepke JA (editor): *Laboratory Hematology*. Churchill Livingstone, New York, NY, 1984; 789-818.

Wang JS, Lin Cy, Hung WT, Thisted RA, Karp RB: In vitro effects of aprotinin on activated clotting time measured with different activators. *J Thorac and Cardiovasc Surg* 1992; 104: 1135-1140.

Sanders PW, Curtis JJ: Management of anticoagulation for hemodialysis. In: Nissenson AR, Fine RN (editors): *Dialysis Therapy*. C.V. Mosby Company, St. Louis, MO, 1986, pp. 39-41.

Gambino R: Monitoring heparin therapy. *Lab Report for Physicians* 1982; 4: 17-20.

Lindsay RM: Practical use of anticoagulants. In Drukker W, Parsons FW, Maher JF (editors): *Replacement of renal function by dialysis*. Martinus Nijhoff Publishers, 1983; 201-222.

Scott JA, Berenstein A, Blumenthal D: Use of the activated clotting time as a measure of anticoagulation during interventional procedures. *Radiology* 1986; 158: 849-850.

Esposito RA, Culliford AT, Colvin SB, Thomas SJ, et al: The role of activated clotting time in heparin administration and neutralization for cardiopulmonary bypass. *J Thorac Cardiovasc Surg* 1983;85:174-185.

Ogilby JD, Kopelman HA, Klein LW, Agarwal JB: Adequate heparinization during PTCA: Assessment using activated clotting time. *JACC* 1988, 11: 237A.

Bull BS, Korpman RA, Huse WM, Briggs BD: Heparin therapy during extracorporeal circulation: I. Problems inherent in existing heparin protocols. *J Thorac Cardiovasc Surg* 1975; 69: 674-684.

Wehrmacher WH: Guarding the prothrombin. *Current Medical Digest* 1967; 34: 432.



Actalyke[®] MINI II

Operator's Manual

For additional information, call
Helena Laboratories at 800-231-5663, toll free.



Helena Laboratories, Corp.
1530 Lindbergh Drive
Beaumont, TX 77707
USA



Advena Ltd.
Tower Business Centre, 2nd Flr.,
Tower Street, Swatar, BKR 4013
Malta